

MODEL 32
**MAY BE INSTALLED IN A SOLID FUEL BURNING FIREPLACE, AS A
FREESTANDING FIREPLACE OR WITH AN
OPTIONAL WOODEN SURROUND**

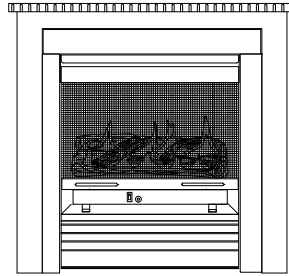

VENT-FREE



WARNING: If the information in this manual is not followed exactly, a fire or explosion may result causing property damage, personal injury or loss of life.

- Do not store or use gasoline or other flammable vapors and liquids in the vicinity of this or any other appliance.

WHAT TO DO IF YOU SMELL GAS

- Do not try to light any appliance.
- Do not touch any electrical switch; do not use any phone in your building.
- Immediately call your gas supplier from a neighbor's phone. Follow the gas supplier's instructions.
- If you cannot reach your gas supplier, call the fire department.
- Installation and service must be performed by a qualified installer, service agency or the gas supplier.

This is an unvented gas-fired heater. It uses air (oxygen) from the room in which it is installed. Provisions for adequate combustion and ventilation air must be provided. Refer to section "Producing Adequate Ventilation" page 12.

This appliance may be installed in an aftermarket, permanently located, manufactured (mobile) home, where not prohibited by local codes.

This appliance is only for use with the type of gas indicated on the rating plate. This appliance is not convertible for use with other gases.

WARNING

This appliance is equipped for (natural or propane) gas .
Field conversion is not permitted.

INSTALLER: Leave this manual with the appliance.
CONSUMER: Retain this manual for future reference.

Manufacturer: NEW BUCK CORPORATION
P.O. Box 69
8000 Highway 226 South
Spruce Pine, NC 28777

This appliance is intended for supplemental heating.

Revised December 2006

TABLE OF CONTENTS

Safety Information and Warnings.....	3
Solid Fuel Burning Fireplace Installation (FP).....	6
Freestanding Installation Without or With Optional Pedestal (FS).....	8
Wooden Surround Installation (WS).....	10
Mobile Home Installation.....	11
Producing Adequate Ventilation.....	12
Ventilation Air Indoors.....	14
Ventilation Air Outdoors.....	15
Placement of Logs.....	16
Gas Connection.....	17
Gas Pressure Check.....	18
Lighting Instructions - (ITT) Millivolt Valve.....	19
Lighting Instructions - (SIT) Modulating or – (SIT) Manual.....	23
Flame Check.....	27
Wiring Diagram.....	28
Important Safeguards.....	29
Trouble Shooting.....	30
Service/Replacement Parts.....	34
Warranty/Owner Registration.....	39

SECTION I

SAFETY INFORMATION WARNINGS

IMPORTANT: READ THIS OWNER'S MANUAL CAREFULLY AND COMPLETELY BEFORE TRYING TO ASSEMBLE, OPERATE, OR SERVICE THE APPLIANCE. IMPROPER USE OF THESE LOGS CAN CAUSE SERIOUS INJURY OR DEATH FROM BURNS, FIRE, EXPLOSION, AND CARBON MONOXIDE POISONING.

Early signs of carbon monoxide poisoning resemble the flu, with headaches, dizziness, and/or nausea. If you have these signs, the heater may not be working properly. Get fresh air at once! Have heater serviced.

Some people-pregnant women, persons with heart or lung disease, anemia, those under the influence of alcohol, and those at high altitudes-are more affected by carbon monoxide than others.

CAUTION: Strong drafts, such as a ceiling fan placed directly in front of the heater (pulling from either direction) may create sooting. Sooting will discolor walls.

1. The installation must conform with local codes ,or in the absence of local codes, with the *National Fuel Gas Code, ANSI Z223.1/NFPA54.*
2. **This appliance may be installed in an After-Market* Manufactured (Mobile) Home, where not prohibited by state or local codes.**
* (After-Market: Completion of sale, not for purpose of resale from the manufacturer.)

This appliance is only for use with the type of gas indicated on the rating plate. This appliance is not convertible for use with other gases.

NOTE: "Producing Adequate Ventilation" page 12.

IMPORTANT: VENT-FREE HEATERS ADD MOISTURE TO THE AIR. ALTHOUGH THIS IS BENEFICIAL, INSTALLING HEATER IN ROOMS WITHOUT ADEQUATE VENTILATION MAY CAUSE MILDEW TO FORM FROM TOO MUCH MOISTURE.

3. Never install this heater:
 - ◆ in a recreational vehicle, bathroom, bedroom, or any other sleeping quarters
 - ◆ where curtains, furniture, clothing, or other flammable objects are less than 42" from the front of the heater
 - ◆ in high traffic areas or in windy areas
4. Two models are available. One specific model for propane (LP), and one for natural gas. Use the correct type gas for your home. Do not convert from one gas type to another.

"WARNING: ANY CHANGE TO THIS HEATER OR ITS CONTROLS CAN BE DANGEROUS."

5. If this heater is used with propane gas, do not place propane supply tank (s) inside any structure.
6. **What To Do IF You Smell Gas:**
Shut off gas supply.
 - Do not try to light any appliance.
 - Do not touch any electrical switch; do not use any phone in your building.
 - Immediately call your gas supplier from a neighbor's phone.
Follow the gas supplier's instructions.
 - If you cannot reach your gas supplier, call the fire department.
7. When operated for the first time, the logs may emit a "paper burning" smell. This smell will gradually diminish and will be totally eliminated after the first few hours of operation. Run the gas logs with the flue damper open during this time. Do not use blower at this time.
8. **"This heater shall not be installed in a confined space or unusually tight construction unless provisions are provided for adequate combustion and ventilation air."** See *"Producing Adequate Ventilation"*, page 12.
9. Surface of gas logs becomes very hot when operating. Keep children and adults away from hot surface. Gas logs will remain hot for sometime after shutdown. Allow surface to cool before touching.
10. **Do not place clothing or other flammable material on or near the appliance.**
11. If equipped, fresh air damper must be closed.
12. **Keep appliance area clean and free from combustible materials, gasoline, and other flammable flammable vapors and liquids.**
13. If burner shuts off, do not relight until you provide fresh outside air. If burner continues to shut off, have unit serviced.
14. **Do not use this heater if any part has been under water. Immediately call qualified service technician to inspect the room heater and to replace any part of the control system and any gas control which has been under water.**
15. Turn off the heater and let cool before servicing.
16. These logs are made of bonded fiber. When removing logs and base, do not damage the bonded material. If the material is damaged extensively, loose fiber dust could be emitted into the air.
17. **Any safety screen or guard removed for servicing an appliance must be replaced prior to operating the heater.**
18. **This appliance is intended for supplemental heating.**
19. **"WARNING: Any change to this heater or its controls can be dangerous."**
20. **Installation and repairs should be performed by a qualified service person. The appliance should be inspected before use and at least annually by a professional service person. More frequent cleaning may be required due to excessive lint from carpeting, bedding material, etc. It is imperative that control compartments, burners and circulating air passageways of the appliance be kept clean.**

21. All heater screens must be kept clean when operating the gas logs.
22. **.”WARNING: Failure to keep the primary air opening (s) of the burner (s) clean may result in sooting and property damage.”**
23. Do not use this heater for burning trash or cooking. Never place matches, paper, garbage, or any other material on top of logs or into the flames.
24. **Do not install or operate this heater in areas where impurities in the air exist (such as tobacco smoke or heavy cooking grease). Particles from impurities may discolor walls.**
25. **Due to high temperatures, the appliance should be located out of traffic and away from furniture and draperies.**
26. **Children and adults should be alerted to the hazards of high surface temperature and should stay away to avoid burns or clothing ignition.**
27. **Young children should be carefully supervised when they are in the same room with the appliance.**
28. **An unvented room heater having an input rating of more than 10,000 Btu per hour shall not be installed in a bedroom or bathroom.**
29. **The appliance and its appliance main gas valve must be disconnected from the gas supply piping system during any pressure testing of that system at test pressure in excess of 1/2 psi (3.5 kPa).**
30. **The appliance must be isolated from the gas supply piping system by closing its equipment shut-off valve during any pressure testing of the gas supply piping system at test pressures equal to or less than 1/2 psi (3.5 kPa).**
31. **“WARNING: Do not allow fans to blow directly into fireplace. Avoid any drafts that alter burner flame patterns.”**
32. **“WARNING: Do not use a blower insert, heat exchanger insert or other accessory not approved for use with this heater.”**
33. **Adequate clearances around air openings.** Nothing may be placed over any of the air openings on this appliance, or can any of the air openings be modified in anyway.
34. **“Trim panels or surrounds shall not seal ventilation openings in the fireplace.”**
35. **“A fireplace screen must be in place when the appliance is operating and, unless other provisions for combustion air are provided, the screen shall have opening(s) for introduction of combustion air.**

MASONRY INSERT INSTALLATION/ SOLID FUEL BURNING FIREPLACE MODEL 32 (FP)

- The Model 32 (FP) may be installed in a masonry fireplace.
Minimum fireplace dimensions: 25 1/2" high, 21-1/2" wide, 13" deep.

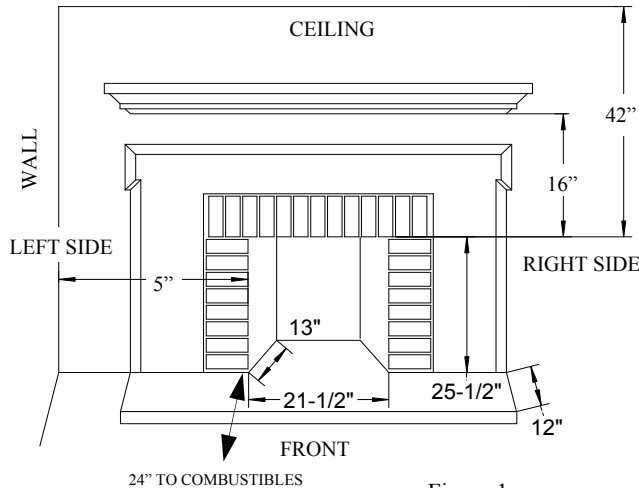

Figure 1

“WARNING: Before installing in a solid-fuel burning fireplace, the chimney flue and firebox must be cleaned of soot, creosote, ashes and loose paint by a qualified chimney cleaner.”

NOTE: Any outside air ducts and / or ash dumps in the fireplace shall be permanently closed at time of appliance installation.

“WARNING: Any glass doors shall be fully opened when appliance is in operation.”

Your new Buck Vent-Free gas heater may be installed in a Residential or *After-Market Mobile Home, where prohibited by state or local codes.

*After-Market: Completion of sale. Not for purpose of resale from the manufacturer.

This appliance is for use with the type of gas indicated on the rating plate. Not convertible for use with other gases.

- Minimum dimensions sidewall and mantel:
Sidewall-not less than 5" See Figure 1.
Mantel-not less than 16" See Figure 1.
- Center Model 32 in masonry fireplace. Position front of heater even with front of fireplace chamber if possible.
- Place side trim panels flat against the fireplace. Draw a vertical reference line along the inside edge of the trim panel.
- Place top trim panel on top of unit. Draw reference line for mounting on lower edge of pane

NOTE: The installer of this appliance must mechanically (peel and stick) attach the marking supplied with this unvented appliance before installing to the inside of the firebox of the solid-fuel burning fireplace or listed ventless firebox enclosure into which the unvented fireplace insert is installed. See the example of the marking on page 18 of this manual.

CAUTION: Cutting any sheet-metal parts of the solid-fuel burning fireplace or listed ventless enclosure in which the unvented fireplace is to be installed is prohibited.

NOTE: “If the factory-built fireplace has no gas access hole(s) provided, an access hole of 1.5 inch (37.5) diameter or less may be drilled through the lower sides or bottom of the firebox in a proper workmanlike manner. This access hole must be plugged with non-combustible insulation after the gas supply line has been installed.”

“Refractory, glass doors, screen rails, screen mesh and solid-fuel log grates (if applicable) can be removed from the fireplace before installing the unvented fireplace insert.”

“Smoke shelves shields and baffles may be removed if attached by mechanical fasteners.”

6. Slide the unit out and install the trim panels with a drill or screw gun. (Self tapping screws provided).

NOTE: Make sure the gas supply line is hooked up at this time, and check for leaks at the connection using soap and water.

CAUTION: Do Not use an open flame to check for leaks.

7. Place logs on the burner base as shown on page 16.
8. For gas hookup and pressure tap test, see instructions on pages 17 & 18.

NOTE: When operated for the first time, the logs and paint may emit a “paper burning smell”. This smell will gradually diminish after a few hours of operation. Run the heater with the flue damper, windows or doors, open during this time. DO NOT use blower at this time.

FREESTANDING INSTALLATION MODEL 32 (FS)

1. Determine the exact location of your gas heater.

NOTE: Due to high temperatures, this heater should be located out of traffic areas and away from furniture and draperies.

NOTE: For safe installation the minimum clearances must be met. See Figure 2. For floor protector, see last paragraph, page 8.

NOTE: Clearance from top of appliance to ceiling is 42". (Not shown in figure 2)

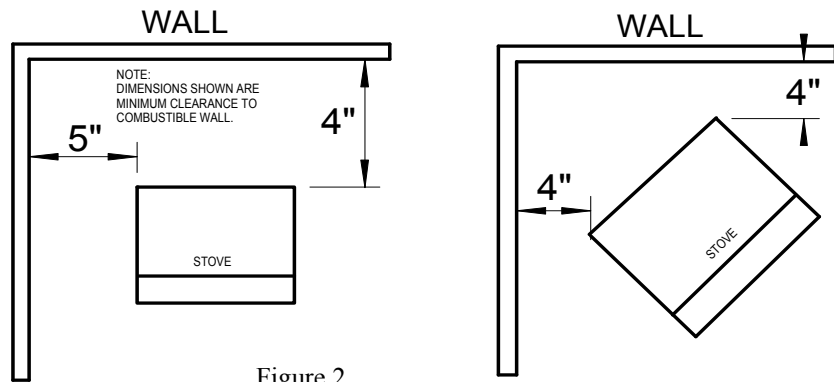

Figure 2

CAUTION: THE INSTALLATION MUST CONFORM TO LOCAL CODES. IN THE ABSENCE OF LOCAL CODES, INSTALLATION MUST CONFORM WITH THE NATIONAL FUEL GAS CODE, ANSI Z223.1/NFPA54.

NOTE: See page 17 for “Gas Connection” and page 18 for “Pressure Check”.

2. Check gas type. Use only the type of gas indicated on the valve rating plate. If the type of gas listed on the plate is not your type of gas supply, **DO NOT INSTALL.** Contact your dealer for proper model. Position logs as shown on page 16. Position screen before leaving heater unattended.

WARNING: YOUNG CHILDREN SHOULD BE CAREFULLY SUPERVISED WHEN THEY ARE IN THE SAME ROOM AS THE HEATER. DO NOT PLACE CLOTHING OR OTHER FLAMMABLE MATERIAL ON OR NEAR THE HEATER.

NOTE: When the appliance is installed directly on carpeting, tile or other combustible material, other than wood flooring, the appliance shall be installed on a metal or wood panel extending the full width and depth of the appliance.

Optional Pedestal (Part#FAP11) Instructions: Lay the heater on its back (use a drop-cloth to protect the back of the heater and the surface of your flooring). Place pedestal against the bottom of the heater. Center pedestal from left to right and from front to rear. Mark the holes on the angle of the top of the

pedestal onto the bottom of the heater. Lay the pedestal aside. Drill the marks made onto the heater with a 1/8” bite (not provided). Replace the pedestal and secure with the screws provided. **Next** stand the heater to the upright position. Place the heater in the desired location following the clearances above in figure 2. **Note:** At this point you may need to secure the pedestal to the floor with screws or an “ell” bracket (not provided) for safety concerns. **Next** hook up the gas supply line following the instructions in this manual completely.

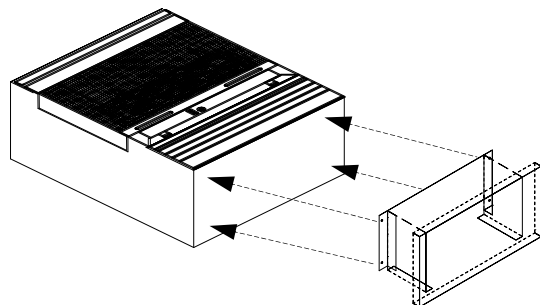

ALCOVE INSTALLATION

CAUTION: READ ENTIRE MANUAL BEFORE INSTALLING HEATER.

1. For clearances, see Figure 3. The minimum clearances must be met.
2. For “Installation and Gas Connection”, see page 17.

FOR YOUR SAFETY:

WHAT TO DO IF YOU SMELL GAS

- Do not try to light appliance.
- Do not touch any electrical switch.
- Do not use telephone in building.
- Call your gas supplier immediately, from a neighbor’s phone. Follow the gas supplier instructions.
- If you cannot reach your gas supplier, call the Fire Department.
- Do not store or use gasoline or any other flammable vapors or liquids in the vicinity of this appliance or any other appliance.

WARNING: DO NOT USE THIS ROOM HEATER IF ANY PART HAS BEEN UNDER WATER. IMMEDIATELY CALL A QUALIFIED SERVICE TECHNICIAN TO INSPECT THE ROOM HEATER AND TO REPLACE ANY PART OF THE CONTROL SYSTEM AND ANY GAS CONTROL WHICH HAS BEEN UNDER WATER.

WARNING: IMPROPER INSTALLATION, ADJUSTMENT, ALTERATION, SERVICE, OR MAINTENANCE CAN CAUSE PROPERTY DAMAGE, PERSONAL INJURY OR LOSS OF LIFE. INSTALLATION AND SERVICE MUST BE PERFORMED BY A QUALIFIED INSTALLER, SERVICE AGENCY OR THE GAS SUPPLIER.

“WARNING: ANY CHANGE TO THIS HEATER OR ITS CONTROLS CAN BE DANGEROUS.”

NOTE: The depth of the alcove must allow a **4”** minimum clearance at the rear. The width of the alcove must allow a **5”** clearance on the right side and the left side. The height of the alcove must allow for a **10”** clearance from the top of the heater to the ceiling of the alcove. The front edge of the heater must meet the front of the alcove, and have a minimum of **24”** to any combustible material.

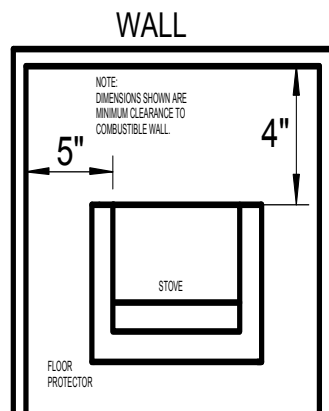
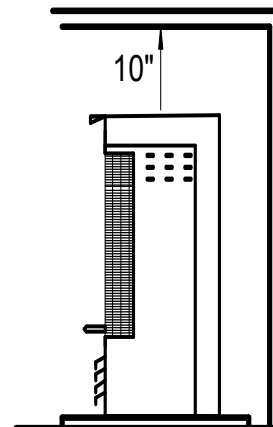

Figure 3



INSTALLATION OF MODEL 32 (WS) WITH OPTIONAL WOODEN SURROUND(KIT#PA-KDM32)

- A. Determine the desired location for your heater and wooden surround. See “Freestanding Installation” for minimum clearances.
- B. To install metal filler strips to the surround (after completing step 2 of surround assembly), position the wooden mantel over the unit, centering it up in the cabinet. Place the metal filler strips to the side of the cabinet, allowing 1/4" air space between the strips and side of the cabinet. Make a light pencil mark on strip. Remove the wooden mantel from around cabinet. Align the pencil mark with the inner edge of the cabinet from back side. Using the screws provided with heater, fasten strips to the back of the mantel. (At this point complete steps 3 and 4 of surround assembly)
- C. Make sure wooden mantel is in correct position. Place the heater into the surround. Connect gas line to the heater, following all the instruction in this manual completely
- D. Make sure you leave 1/4" space between the metal filler strip and the top and sides of the heater. You will also want to position the heater so you have 5 1/2" from outer lip of hot air vent to the pieces of metal strips, not the wooden face of the mantel. See Figure 4.

NOTE: You will need to leave 1/2" space between the back of the wooden mantel and an adjacent combustible wall.

NOTE: If a masonry hearth is built up under front bottom of heater, and you do not use the hearth provided with the wooden surround, you must have 12" of non-combustible material from front bottom edge of heater.

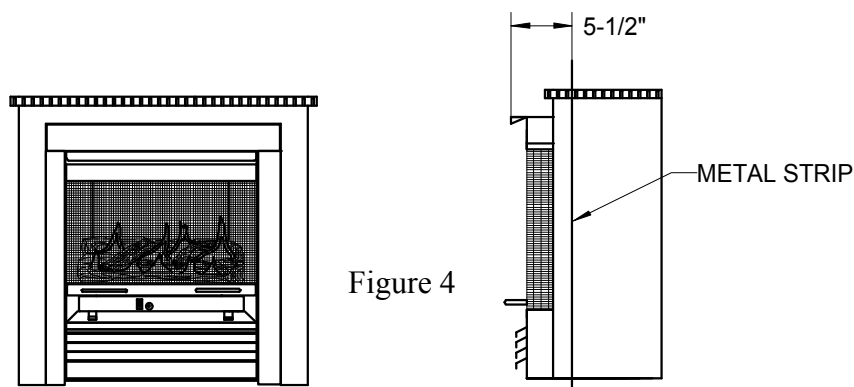

(WS) ASSEMBLY INSTRUCTIONS

Tools Needed: Medium Phillips Screwdriver

Step 1: Lay out all components. (See diagram 1)

Step 2: Assemble end panels (A & B) to top front rail (C). (See section “B” above on this page)

Step 3: Stand end panels and top front rail onto hearth and fasten down with screws provided (See diagram 1).

NOTE: Position back of end panels with back of hearth centering assembly from each end. Install front screws first, then pull back towards the inside to square the surround (mantel) up. Install screws through back holes.

Step 4: Place top onto surround, flush with back and equal on each end. Secure both ends and middle with screws provided.

CONTINUED ON PAGE 11

EXPLODED VIEW OF MODEL 32 (WS)

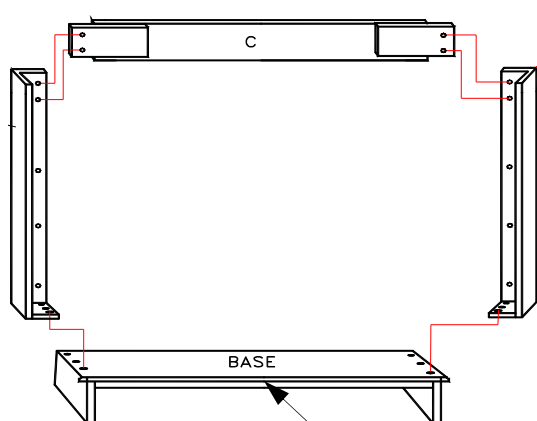

WOODEN SURROUND BASE (HEARTH)

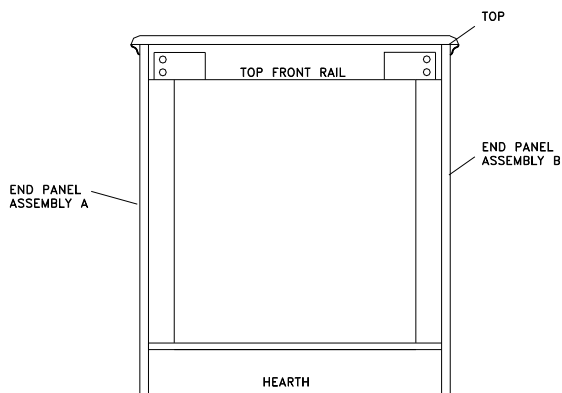

(SHOWN AS VIEWED FROM REAR OF SURROUND)

INSTALLATION IN RESIDENTIAL OR AFTER-MARKET MOBILE HOMES

NOTICE:

**A QUALIFIED SERVICE TECHNICIAN MUST INSTALL THIS HEATER.
CHECK FOR STATE AND LOCAL CODES CONCERNING INSTALLATION
REQUIREMENTS.**

CHECK GAS TYPE:

THIS APPLIANCE IS ONLY FOR USE WITH THE TYPE OF GAS INDICATED ON THE RATING PLATE. THIS APPLIANCE IS NOT CONVERTIBLE FOR USE WITH OTHER GASES.

INSTALLATION SUPPLIES:

Before installing the heater, gather the following materials:

- external regulator (supplied by installer for propane)
- piping (check local codes)
- manual shutoff valve*
- test gauge connection*
- ground joint union
- sediment trap
- tee joint
- pipe wrench
- sealant (resistant to LP gas)

* An C.S.A. design-certified manual shutoff valve with 1/8" NPT tap is an acceptable alternative to test gauge connection. Purchase the optional C.S.A. design-certified manual shutoff valve from your dealer.

WARNING

MAINTAIN THE MINIMUM CLEARANCES SHOWN THROUGHOUT THIS MANUAL. IF POSSIBLE, PROVIDE GREATER CLEARANCES FROM FLOOR, CEILING, AND ADJOINING WALL.

NOTE: See "Producing Adequate Ventilation" page 12.

.THIS APPLIANCE MAY BE INSTALLED IN AN AFTERMARKET*, PERMANENTLY LOCATED, MANUFACTURED (MOBILE) HOME, WHERE NOT PROHIBITED BY LOCAL CODES.

**After Market: Completion of sale, not for the purpose of resale from the manufacturer.*

PRODUCING ADEQUATE VENTILATION

This section is for residential or manufactured (mobile) installation

“This heater shall not be installed in a confined space or unusually tight construction unless provisions are adequate combustion and ventilation air.”

The **National Fuel Gas Code, ANSI Z223.1/NFPA 54** defines a confined space as a space whose volume is less than 50 cubic feet per 1,000 BTU per hour (4.8m³ per kw) of the aggregate input rating of all appliances installed in that space and an unconfined space as a space whose volume is not less than 50 cubic feet per 1,000 BTU per hour (4.8m³ per kw) of the aggregate input rating of all appliances installed in that space. Rooms communicating directly with the space in which the appliances are installed, through openings not furnished with doors, are considered a part of the unconfined space.

“WARNING: IF THE AREA IN WHICH THE HEATER MAY BE OPERATED IS SMALLER THAN THAT DEFINED AS AN UNCONFINED SPACE OR IF THE BUILDING IS OF UNUSUALLY TIGHT CONSTRUCTION, PROVIDE ADEQUATE COMBUSTION AND VENTILATION AIR BY ONE OF THE METHODS DESCRIBED IN THE NATIONAL FUEL GAS CODE, ANSI Z223.1/NFPA 54, SECTION 5.3 OR APPLICABLE LOCAL CODES.”

Unusually tight construction is defined as construction where:

- Walls and ceilings exposed to the outside atmosphere have a continuous water vapor retarder with a rating of 1 perm (6×10^{-11} kg per pa-sec-m²) or less with openings gasketed or sealed;
- Weather stripping has been added on openable windows and doors, and
- Caulking or sealants are applied to areas such as joints around window and door frames, between sole plates and floors, between wall-ceiling joints, between wall panels, at penetrations for plumbing, electrical, and gas lines, and at other openings.

NOTE: SOME AREAS IN THE UNITED STATES HAVE HIGHER REQUIREMENTS FOR CUBIC FEET PER 1000 BTU/ HOUR INPUT. (EX. CINCINNATI, OHIO CODES REQUIRE 70 CUBIC FEET). CHECK YOUR LOCAL CODE BEFORE INSTALLATION.

DETERMINING FRESH-AIR FLOW FOR HEATER LOCATION

DETERMINE IF YOU HAVE A CONFINED OR UNCONFINED SPACE

Use this worksheet to determine if you have confined or unconfined space.

SPACE: Includes the room in which you will install heater plus adjoining rooms with doorless passageways or ventilation grills between the rooms.

1. **Determine the volume of the space (length x width x height).**

Length x Width x Height = _____ cu.ft.(volume of space)

EXAMPLE: 20 ft.(Length) x 16 ft.(Width) x 8 ft.(ceiling Height)=
2560 cu. ft. (volume of space)

If additional ventilation to adjoining room is supplied with grills or openings, add the volume of these rooms to the total volume of the space.

2. **Divide the space volume by 50 cubic feet to determine the maximum BTU/Hr the space can support.**

_____ (volume of space)/50 cu. ft. =maximum BTU/Hr the space can support)

EXAMPLE: 2560 cu. ft. (volume of space /50 cu. Ft. = 51.2 or
51200 (maximum BTU/Hr the space can support)

3. Add the BTU/Hr of all fuel burning appliances in the space.

Vent-free heater	_____	BTU/Hr
Gas water heater*	_____	BTU/Hr
Gas furnace	_____	BTU/Hr
Vented gas heater	_____	BTU/Hr
Gas fireplace logs	_____	BTU/Hr
Other gas appliances*	+ _____	BTU/Hr
Total	= _____	BTU/Hr

Example: Gas water heater 40000 BTU/Hr
Vent-free heater + 18000 BTU/Hr
Total = 58000 BTU/Hr

*Does not include direct-vent gas appliances. Direct-vent draws combustion air from the outdoors and vents to the outdoors.

4. Compare the maximum BTU/Hr the space can support with the actual amount of BTU/Hr used.

_____ BTU/Hr (maximum the space can support)
_____ BTU/Hr (actual amount of BTU/Hr used)

Example: 51200 BTU/Hr (maximum the space can support)
58000 BTU/Hr (actual amount of BTU/Hr used)

The space in the above example is a confined space because the actual BTU/Hr used is more than the maximum BTU/Hr the space can support. You must provide additional fresh air. Your options are as follows: A. Rework worksheet, adding the space of an adjoining room. If the extra space provides an unconfined space, remove door to adjoining room or add ventilation grills between rooms. See "Ventilation Air From Inside Building", page 21.

B. Vent room directly to the outdoors. See "Ventilation Air From Outdoors", page 22.

C. Install a lower BTU/Hr heater, if lower BTU/Hr size makes room unconfined.

If the actual BTU/Hr used is less than the maximum BTU/Hr the space can support, the space is an unconfined space. You will need no additional fresh air ventilation.

WARNING: YOU MUST PROVIDE ADDITIONAL VENTILATION AIR IN A CONFINED SPACE

VENTILATION AIR

VENTILATION AIR FROM INSIDE BUILDING

This fresh air would come from an adjoining unconfined space. When venting to an adjoining space, you must provide two permanent openings: one within 12" of the ceiling and one within 12" of the floor on the wall connecting the two spaces. (See Options 1 and 2, Figure 5). You can also remove door into adjoining room. (See Option 3, Figure 5).

WARNING

REWORK WORKSHEET, ADDING THE SPACE OF THE ADJOINING UNCONFINED SPACE. THE COMBINED SPACES MUST HAVE ENOUGH FRESH AIR TO SUPPLY ALL APPLIANCES IN BOTH SPACES.

NOTE: Each opening shall have a minimum free area of 1 square inch per 1000 BTU's per hour of the total input ratings of all gas utilization equipment in the confined space, but not less than 100 square inches.

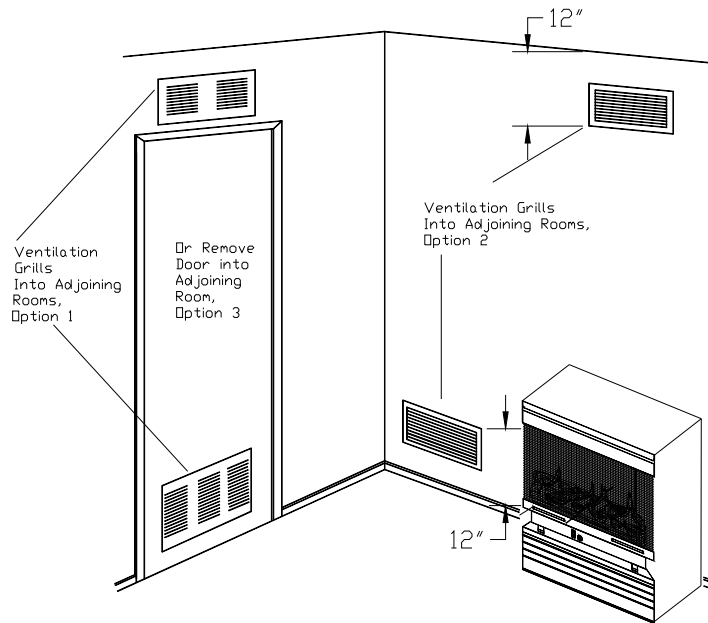

Figure 5: Ventilation Air From Inside Building

NOTE: Drill holes on bottom of pedestal base on each corner. Unit must be fastened to floor with screws.

WARNING

THIS HEATER MUST HAVE FRESH AIR FOR PROPER OPERATION. IF NOT, POOR FUEL COMBUSTION COULD RESULT. READ THE FOLLOWING INSTRUCTIONS TO ENSURE PROPER FRESH AIR FOR THIS AND OTHER FUEL-BURNING APPLIANCES IN YOUR HOME.

VENTILATION AIR FROM OUTDOORS

Provide extra fresh air by using ventilation grills or ducts. You must provide two permanent openings: one within 12" of the ceiling and one within 12" of the floor. Connect these items directly to the outdoors. These spaces include attics and crawl spaces. Follow the National Fuel Gas Code NFPA 54/ANSI Z223.1, Section 4.3, "Air For Combustion and Ventilation" for required size of ventilation grills or ducts. See Figure 6.

IMPORTANT: Do not provide openings for inlet air into attic if attic has a thermostat-controlled power vent. Heated air entering the attic will activate the power unit.

Figure 6: Ventilation Air From Outdoors

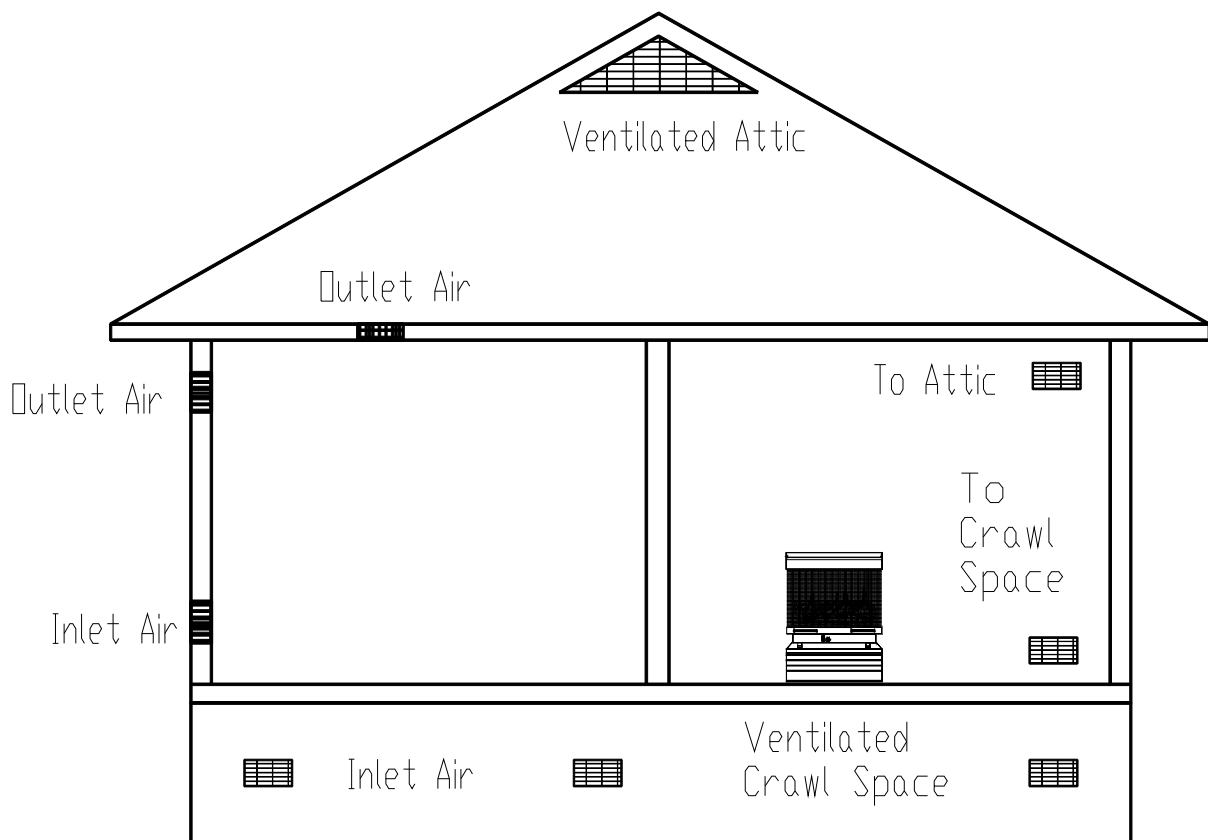

PREPARING LOG KIT

Open the cartons containing the Burner Base and the M-3019 logs. The logs are numbered as follows: (1) Front, (2) Rear, (3) Right side top, (4) Left side top.

WARNING: POSITIONING OF LOGS IS VERY CRITICAL (SEE FIGURE 7).

- (1) POSITION REAR LOG (#2) , IN REAR LOG HOLDERS, CENTERING LEFT TO RIGHT.
- (2) PLACE FRONT LOG (#1) OVER FRONT PART OF BURNER TUBE. LOCATE LOG IN THE CENTER OF THE BURNER BASE. MAKE SURE THE MIDDLE SUPPORT LEG OF THE FRONT LOG IS IN THE HOLDERS LOCATED IN THE CENTER OF THE BURNER BASE, JUST BEHIND THE FRONT PART OF THE BURNER TUBE.
- (3) TAKE RIGHT TOP LOG (#3) AND PLACE IT IN THE SLOTS LOCATED AT THE RIGHT SIDE OF THE FRONT AND REAR LOGS, FACING THE BURNER BASE.
- (4) PLACE LEFT TOP LOG (#4) IN THE SLOTS OF THE LEFT FRONT AND REAR LOGS.
- (5) WHEN IGNITING THE BURNER, CHECK AND MAKE SURE THE FLAME IS NOT TOUCHING EITHER SIDE OF LOG (#3), OR LOG (#4). IF FLAME IS TOUCHING LOGS ON EITHER SIDE, MOVE SLIGHTLY TO THE LEFT OR RIGHT TO ELIMINATE THE FLAME FROM TOUCHING EITHER LOG.

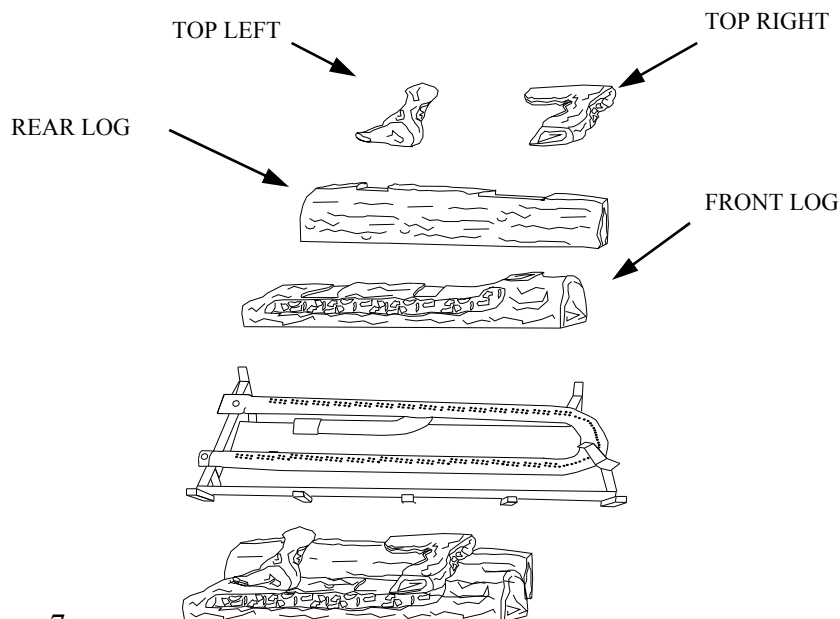

Figure 7

WARNING: Failure to position the parts in accordance with these diagrams or failure to use only parts specifically approved with this heater may result in property damage or personal injury.

GAS CONNECTION

Check gas type. Use only the type of gas indicated on the valve rating plate. If the gas type listed on the plate is not your type of gas supply, **DO NOT INSTALL**. Contact your dealer for proper model.

Always use an external regulator for all LP heaters to reduce the supply tank pressure to a maximum of 14" W.C. This is in addition to the regulator furnished with the heater.

WARNING: CONNECTION DIRECTLY TO AN UNREGULATED LP TANK CAN CAUSE AN EXPLOSION.

The normal gas connection is 3/8" N.P.T. made at the left side (facing the front of the appliance) of the appliance. If a right side connection is desired, the connecting pipe may be led under the rear of the burner base to terminate at the right hand side for connection at the inlet of the valve.

NOTE: The connecting pipe must be internally tinned copper tubing for use with natural gas. Test for leaks using a solution of soap and water after completing the connection. **DO NOT USE OPEN FLAME.**

WARNING: ANY CHANGE TO THIS HEATER OR ITS CONTROLS CAN BE DANGEROUS.

NOTE: "If the factory-built fireplace has no gas access hole(s) provided, an access hole of 1.5 inch (37.5mm) diameter or less may be drilled through the lower sides or bottom of the fire box in a proper workmanlike manner. This access hole must be plugged with non-combustible insulation after the gas supply line has been installed."

WARNING: Installation and repairs should be performed by a qualified service person. The appliance should be inspected before use and at least annually by a professional service person. More frequent cleaning may be required due to excessive lint from carpeting, bedding material, etc. It is imperative that control compartments, burners and circulating air passageways of the appliance be kept clean.

GAS PRESSURE CHECK

Check the inlet pressure to the burner to ensure that it is shown in the table below.

NOTE: The pressure check point is located on the right side of the valve facing burner, for SIT Millivolt, and the left side for SIT Modulating.

The appliance and its appliance main gas valve must be disconnected from the gas supply piping system during any pressure testing of that system at test pressures in excess of 1/2 psi (3.5kPa).

The appliance must be isolated from the gas supply piping system by closing its equipment shut-off valve during any pressure testing of the gas supply piping system at test pressures equal to or less than 1/2 psi (3.5 kPa).

VALVE MODEL:	(MILLIVOLT)		(SIT MANUAL-MODULATING)	
	FP32	FP32	FP32	FP32
<u>GAS</u>	<u>Natural</u>	<u>Propane</u>	<u>Natural</u>	<u>Propane</u>
Maximum Heat Input	33,000	33,000	33,000	33,000
Minimum Heat Input	23,000	23,000	12,000	13,000
<u>Gas Inlet Pressure</u>				
Maximum	10.5ins.W.C.	13ins.W.C.	10.5ins.W.C.	9.0ins.W.C.
Minimum	* 5.0ins.W.C.	*11ins.W.C.	*5.0ins.W.C.	*11ins.W.C.
<u>Manifold Pressure</u>				
Maximum	3.5ins.W.C.	9.0ins.W.C.	3.5ins.W.C.	9.0ins.W.C.
Minimum	3.0ins.W.C.	8.2ins.W.C.	2.8ins.W.C.	7.2ins.W.C.

NOTE: On initial installation it may be necessary to bleed out air in the gas lines. Do this by holding the control knob and turning the knob to the “PILOT” position for about 30 seconds.

To check the regulator pressure, remove the pressure tag plug at the left side of the regulator facing the heater. The pressure should be checked with the heater burning and the control set on high. After measuring the pressure, replace the pressure tap plug, ensuring that there are no leaks.

* For the purpose of minimum input adjustment.

WARNING

**This appliance is equipped for (natural or propane) gas.
Field conversion is not permitted.**

Solid fuels shall not be burned in the same fireplace where an unvented room heater has been installed.

NOTE: The following label has been provided with this appliance and must be read and then attached to the floor of the fireplace or firebox area beneath the appliance. The label is a peel and stick label. Make sure the area is cleaned before attaching the label to it.

“WARNING: This solid-fuel burning fireplace or listed ventless enclosure has been converted for use with an unvented fireplace insert only. A solid-fuel burning fireplace cannot be used for burning wood or solid fuels unless all original parts have been replaced, and the fireplace re-approved by the authority having jurisdiction. A ventless firebox enclosure cannot be used with an unvented gas log unless all original parts have been replaced, and the ventless firebox enclosure re-approved by the authority having jurisdiction.”

**LIGHTING INSTRUCTIONS
MILLIVOLT VALVE (ITT)**

FOR YOUR SAFETY, READ BEFORE LIGHTING

WARNING

IF YOU DO NOT FOLLOW THESE INSTRUCTIONS EXACTLY, A FIRE OR EXPLOSION MAY RESULT CAUSING PROPERTY DAMAGE, PERSONAL INJURY, OR LOSS OF LIFE.

- A. This appliance has a pilot which must be lighted by hand. When lighting the pilot, follow these instructions exactly.
- B. **BEFORE LIGHTING** smell around the appliance for gas. Be sure to smell next to the floor because gas is heavier than air and will settle on the floor.

WHAT TO DO IF YOU SMELL GAS

- ◆ Do not try to light any appliance.
 - ◆ Do not touch any electrical switch; do not use any phone in your building.
 - ◆ Immediately call your gas supplier from a neighbor's phone. Follow the gas supplier's instructions.
 - ◆ If you cannot reach your gas supplier, call the fire department.
- C. Use only your hand to push in or turn the gas control knob. Never use tools. If the knob will not push in or turn by hand, don't try to repair it, call a qualified service technician. Force or attempted repair may result in a fire or explosion.
- D. Do not use this appliance if any part has been under water. Immediately call a qualified service technician to inspect the appliance and to replace any part of the control system and any gas control which has been under water.

LIGHTING INSTRUCTIONS

1. **STOP!** Read the safety information on previous page.
2. Make sure the manual shutoff valve is fully closed. If equipped with thermostat set to the lowest setting.
3. Turn off all electrical power to the appliance.
4. Open access panel door located at bottom front of the appliance.
5. Turn control knob clockwise  to the full "OFF" position.

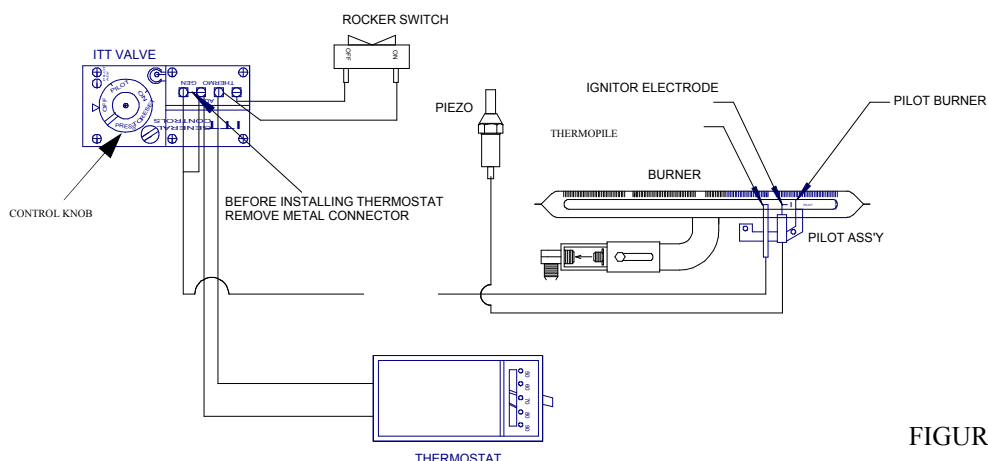

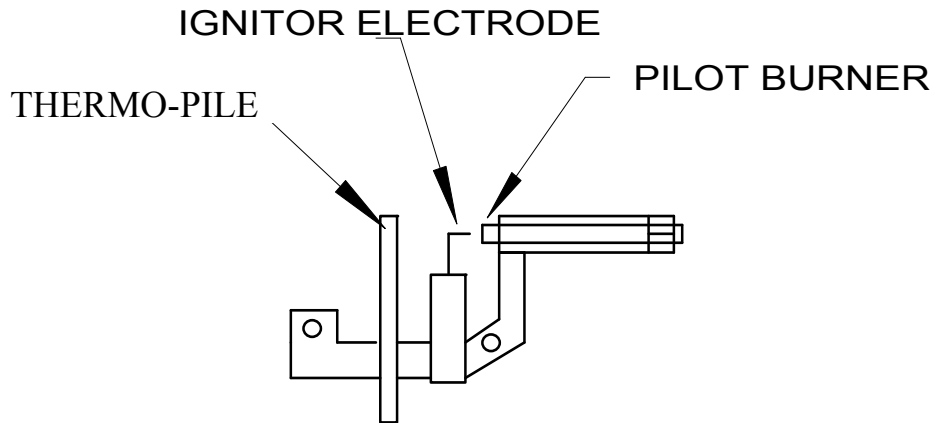



FIGURE: 8

When hooking up a Wall Thermostat to valve, remove the Jumper Bar. Do not remove the existing wires, simply add the wire from the Wall Thermostat to screws (one wire to each screw).

6. Wait five (5) minutes to clear out any gas. Then smell for gas, including near the floor. If you smell gas, **STOP!** Follow "B" in the safety information on the previous page. If you don't smell gas, go to the next step.
 7. Find Pilot: The pilot is located in front of the rear log and burner on the right hand side of the appliance. Fully open the manual shutoff valve.
 8. Push the ON/OFF toggle switch to "OFF" (rocker switch).
 9. Turn gas control knob counterclockwise  to the "PILOT" position. Press in gas control knob for fifteen (15) seconds.
 10. With control knob pressed in, push down (in) and release the ignitor button (ignitor button is located on the left hand side of the front of the appliance). This will light the pilot. If needed, keep repeating this step until pilot lights.
 11. Keep control knob pressed in for (1) one minute after lighting pilot. After (1) minute, release the gas control knob and it will pop back up. Pilot should remain lit. If pilot goes out, repeat steps 1 through 9.
- If the knob does not pop up when released, stop and immediately call your service technician or gas supplier.

- If the pilot will not stay lit after several tries, turn the gas control knob to “OFF” and call your service technician or gas supplier.



12. Turn control knob counterclockwise  to the “ON” position. Push the “ON/OFF” toggle switch to the “ON” position. The main burner should light.
13. Close access panel door.
14. Turn on all electrical power to the appliance.

NOTE: This unit may be used with an optional Wall Thermostat. If so, the Wall Thermostat needs to be set at a higher temperature than the room temperature.

TO TURN OFF GAS TO APPLIANCE

SHUTTING OFF UNIT

1. Open access panel door located at bottom front of the appliance.
2. “If equip with thermostat set to lowest setting.”
3. Turn control knob clockwise  to the “OFF” position.
4. Turn off all electric power to the appliance if service is to be performed.
5. Close access panel door.

SHUTTING OFF BURNER ONLY (Pilot stays lit.)

Turn control knob clockwise  to the “PILOT” position.



CAUTION

DO NOT TRY TO ADJUST HEATING LEVELS BY USING THE MANUAL SHUTOFF VALVE.

THERMOSTAT CONTROL OPERATION

- This valve operates off of millivolts produced by the generator. You may choose to use an optional Wall Thermostat or Remote control. If so, see Figure 2, page 11 for wiring diagram.

MANUAL LIGHTING PROCEDURE

1. If the pilot cannot be lit with the piezo, it can be manually lit with the use of a paper match and a lighter rod.
2. Open access panel door located at bottom front of the appliance.
3. Place the match in the holder and light. With the left hand, turn the control knob counterclockwise  to "PILOT" position. Press in gas control knob for fifteen (15) seconds.
4. Use rod to light match and ignite pilot. The pilot is located in front of the rear log and burner on the right hand side of the appliance.
5. Continue to hold the control knob for an additional one (1) minute to ensure the pilot is lit.
6. Turn control knob counterclockwise  to the "ON" position. Push the "ON/OFF" toggle switch to the "ON" position. The main burner should light.
7. Close access panel door.
8. Turn on all electrical power to the appliance.

NOTE: This unit may be used with an optional Wall Thermostat. If so, the Wall Thermostat needs to be set at a higher temperature than the room temperature.

**LIGHTING INSTRUCTION
MODULATING VALVE (SIT)
OR MANUAL VALVE (SIT)
FOR YOUR SAFETY READ BEFORE LIGHTING**

WARNING

IF YOU DO NOT FOLLOW THESE INSTRUCTIONS EXACTLY, A FIRE OR EXPLOSION MAY RESULT CAUSING PROPERTY DAMAGE, PERSONAL INJURY OR LOSS OF LIFE.”

- A. This appliance has a pilot which must be lighted by hand. When lighting the pilot, follow these instructions exactly.
- B. **BEFORE LIGHTING** smell all around the appliance area for gas. Be sure to smell next to the floor because gas is heavier than air and will settle on the floor.

WHAT TO DO IF YOU SMELL GAS:

- Do not try to light any appliance.
 - Do not touch any electric switch; do not use any phone in your building.
 - Immediately call your gas supplier from a neighbor’s phone. Follow the gas supplier’s instructions.
 - If you cannot reach your gas supplier, call the fire department.”
- C. Use only your hand to push in or turn the gas control knob. Never use tools. If the knob will not push in or turn by hand, don’t try to repair it’ call a qualified service technician. Force or attempted repair may result in a fire or explosion.”
- D. **Do not** use this appliance if any part has been under water. Immediately call a qualified service technician to inspect the appliance and to replace any part of the control system and any gas control which has been under water.”

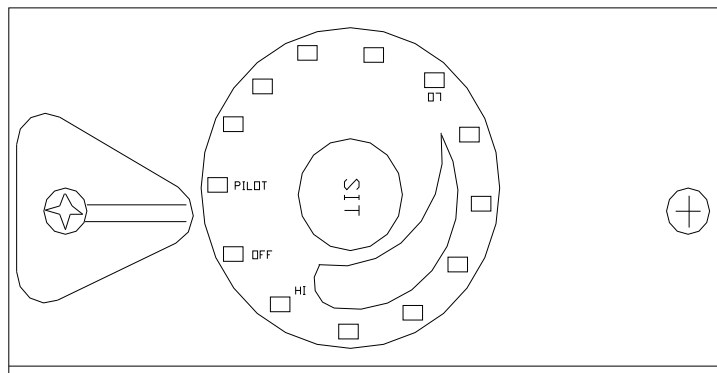

LIGHTING INSTRUCTION

1. **STOP!** Read the safety information on preceding page 19.
2. Make sure manual shutoff valve is fully closed.
3. Turn off all electrical power to the appliance.
4. Open access panel door located at bottom front of the appliance.
5. Turn control knob clockwise  to the full “OFF” position.

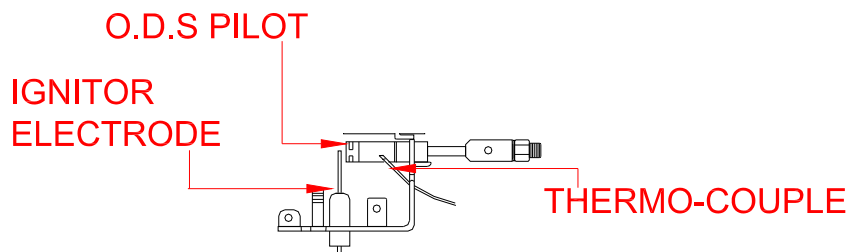

6. Wait five (5) minutes to clear out any gas. Then smell for gas, including near the floor. If you smell gas, **STOP!** Follow “B” on preceding page in the Safety Information. If you don’t smell gas, go to the next step.
7. Find Pilot: The pilot is located in front of the rear log and burner on the right hand side of the appliance. Fully open the manual shutoff valve.
8. Press in and turn gas control knob counterclockwise  to the “PILLOT” position continue pressing in control knob for fifteen (15) seconds.
9. With control knob pressed in, push down (in) and release the ignitor button (ignitor button is located on the left hand side of the gas control valve) . This will light pilot. If needed, keep repeating this step until pilot lights.
10. Keep control knob pressed in for one (1) minute after lighting pilot. After one (1) minute, release control knob and it will pop back up. Pilot should remain lit. If pilot goes out, repeat steps 1 through 9.
 - If the knob does not pop up when released, stop and immediately call your service technician or gas supplier.
 - “If the pilot will not stay lit after several tries, turn the gas control knob to “OFF” and call your services technician or gas supplier.”



11. Turn gas control knob counterclockwise  to “ON” position. Continue to turn the gas control knob counterclockwise  to your desired setting.
12. Close access panel door.
13. Turn on all electrical power to the appliance.

CAUTION

DO NOT TRY TO ADJUST HEATING LEVELS BY USING THE MANUAL SHUTOFF VALVE.

TO TURN OFF GAS TO APPLIANCE

SHUTTING OFF UNIT

1. Open access cover door.
2. Turn gas control knob clockwise  to the full “OFF” position.
3. Turn off all electric power to the appliance if service is to be performed
4. Close access cover door.

SHUTTING OFF BURNER ONLY (pilot stays lit)

Turn control knob clockwise  to the “PILOT” position.

CAUTION: Hot while in operation. Do Not Touch. Keep children, clothing, furniture, gasoline, and other liquids having flammable vapors away.

CAUTION: DO NOT TRY TO ADJUST HEATING LEVELS BY USING THE MANUAL SHUTOFF VALVE.

WARNING: Improper installation, adjustment, alteration, service or maintenance can cause property damage, personal injury, or loss of life. Refer to owner’s information manual provided with this appliance. Installation and service must be performed by a qualified installer, service agency, or the gas supplier.



IMPORTANT: Always operate the appliance at the completely “ON” or the completely “OFF” positions. Never use the heater at a setting between these positions as this can result in improper combustion and excessive carbon monoxide emissions.

THERMOSTAT CONTROL OPERATION

1. The thermostat control on this heater differs from standard thermostats. Standard thermostats simply turn the burner on and off. The thermostat used on this heater senses the room temperature and adjusts the amount of gas flow to the burner. This will increase or decrease the flame height. At times, the room may exceed the set temperature, which will cause the burner to shut off. When room temperature drops below the thermostat setting, the burner will cycle itself on again. The control knob can be set to any level between “LO” and “HI”.

NOTE: The thermostat sensing bulb measures the temperature of air near the heater cabinet. This may not always agree with room temperature (depending on housing construction, installation location, room size, open air temperatures, etc.). Frequent use of your heater will allow you to determine your personal comfort levels.

MANUAL LIGHTING PROCEDURE

1. If the pilot cannot be lit with the piezo, it can be manually lit with the use of a paper match and a lighter rod.
2. Open access panel door located at bottom front of the appliance.
3. Place the match in the holder and light. With the left hand, turn the control knob counterclockwise  to “PILOT” position. Press in gas control knob for fifteen (15) seconds.
4. Use rod to light match and ignite pilot. The pilot is located in front of the rear log and burner on the right hand side of the appliance.
5. Continue to hold the control knob for an additional one (1) minute to ensure the pilot is lit.
6. Turn control knob counterclockwise  to the “ON” position. Push the “ON/ OFF” toggle switch to the “ON” position. The main burner should light.
7. Close access panel door.
8. Turn on all electrical power to the appliance.

NOTE: This unit may be used with an optional Wall Thermostat. If so, the Wall Thermostat needs to be set at a higher temperature than the room temperature.

FLAME CHECK

A periodic check of the flames should be made. The pilot flame should always be present when the gas logs are in operation. See Figure 11.

FLAME:

- Propane (LP) should produce a flame that is about 6" above the rear log. This flame should be yellow.
- Natural gas should produce a flame that is about 3" to 4" above rear log. This flame should be mostly blue except for the top tips which should be yellow.

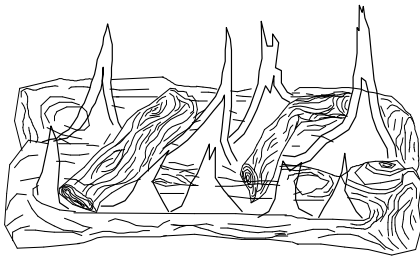

Natural

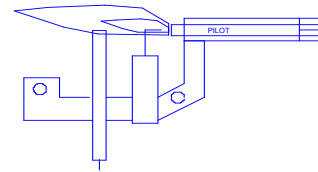

Propane

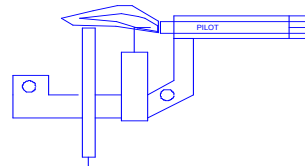

Figure 11

WIRING DIAGRAM

WARNING:

ELECTRICAL GROUNDING INSTRUCTION:

THIS APPLIANCE IS EQUIPPED WITH A THREE-PRONG (GROUNDING) PLUG FOR YOUR PROTECTION AGAINST SHOCK HAZARD AND SHOULD BE PLUGGED DIRECTLY INTO A PROPERLY GROUNDED THREE-PRONG RECEPTACLE.

NOTE: #PESBR084 Blower Motor
Rating: 120 volts/60HZ/1.1 Amps.

NOTE: For convenience, allow licensed electrician to install properly grounded 3-plug receptacle near unit.

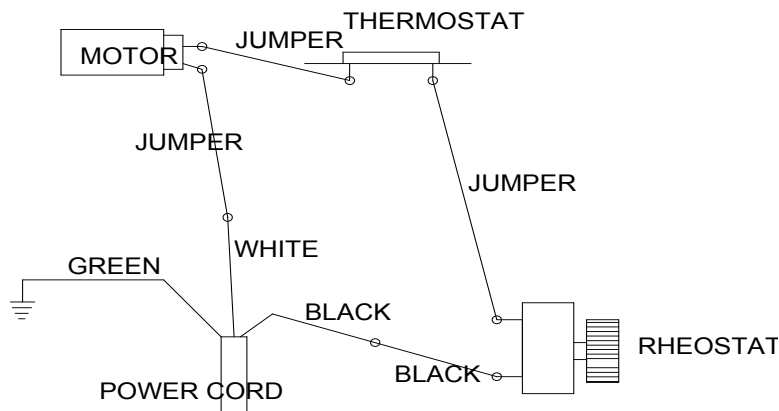

WARNING: CHILDREN AND ADULTS SHOULD BE ALERTED TO THE HAZARDS OF HIGH SURFACE TEMPERATURES AND SHOULD STAY AWAY TO AVOID BURNS OR CLOTHING IGNITION. YOUNG CHILDREN SHOULD BE CAREFULLY SUPERVISED WHEN THEY ARE IN THE SAME ROOM WITH THE APPLIANCE

WARNING: DO NOT PLACE CLOTHING OR OTHER FLAMMABLE MATERIAL ON OR NEAR THE APPLIANCE.

NOTE: "If any of the original wire as supplied with the gas appliance must be replaced, it must be replaced with a wire of at least a 105° C. temperature rating."

NOTE: Installation and repair should be done by a qualified service person. This heater should be inspected before use and at least annually by a qualified service person. More frequent cleaning may be required due to excessive lint from carpeting, bedding material, etc. It is imperative that control compartments and circulating air passageways of the heater be kept clean.

CAUTION: Label all wires prior to disconnection when servicing controls. Wiring errors can cause improper and dangerous operation.

Verify proper operation after servicing.

IMPORTANT SAFEGUARDS

Although your gas logs are very realistic in appearance, it is not a real burning fireplace and must not be used for burning rejected material.

- To avoid irreparable damage to the heater or personal injury, matches, paper, garbage, or any other material **must not** be placed or thrown on top of the logs or into the flames.
- To avoid personal injury, do not touch hot surfaces when the heater is operating.
- Close supervision is necessary when the heater is being operated near children.

WARNING: THE LOGS ARE MANUFACTURED FROM BONDED CERAMIC FIBER. THIS IS A COMMONLY USED MATERIAL IN INDUSTRY WORLDWIDE. IN THE EVENT THAT A LOG SHOULD BE REMOVED, CARE SHOULD BE TAKEN NOT TO DAMAGE THE BONDED MATERIAL. INTENTIONAL MISUSE OR DELIBERATELY FRAGMENTING THE MATERIAL COULD LEAD TO INHALING FIBERS AND BE HAZARDOUS TO YOUR HEALTH.

THIS HEATER IS INTENDED FOR USE AS A GAS HEATER FIREPLACE AS DESCRIBED IN THESE INSTRUCTIONS. IT SHOULD NOT BE USED FOR ANY OTHER PURPOSE.

CLEANING

CAUTION: BEFORE CLEANING OR MOVING THESE LOGS OR OTHER PARTS OF THE HEATER, BE SURE TO READ THE ABOVE SECTIONS ON “IMPORTANT SAFEGUARDS.”

The appliance must be turned “OFF” before cleaning inside the firebox (burn area), make sure the pilot is “OFF” completely and the appliance has cooled.

- All cleaning should be carried out when the heater is cold. Limited cleaning is required with normal use. Dusting the front of the base, the top of the piezo cover, or the control knob panel may be required occasionally. Do not use cleaning fluids to clean the logs or any other part of the heater.
- If the flames show unusual shapes or behavior, or if burner fails to ignite properly, the burner holes may require cleaning. If this occurs, contact your nearest dealer to service the heater.
- The heater can be cleaned by removing the logs. Lift the logs gently, as not to damage the fiber pieces. The logs have been spot glued in place for shipping, use caution when removing. Lift each log by holding it carefully at each end. Use a vacuum cleaner to remove dust and loose particles from the base, logs and around the burner and ODS/Pilot. Gloves are recommended to prevent fibers from breaking the skin. If skin is broken, clean with soap and water.

WARNING: Failure to keep the primary air openings(s) of the burner(s) clean may result in sooting and property damage.

TROUBLE SHOOTING

WARNING

TURN OFF, UNPLUG HEATER AND LET COOL BEFORE SERVICING. ONLY A QUALIFIED SERVICE PERSON SHOULD SERVICE AND REPAIR HEATER.

CAUTION

NEVER USE A WIRE, NEEDLE, OR SIMILAR OBJECT TO CLEAN ODS/PILOT. THIS CAN DAMAGE ODS/PILOT.

OBSERVED PROBLEM	POSSIBLE CAUSE	SOLUTION
Igniter button is pressed no spark at ODS/Pilot	1. Igniter electrode positioned incorrectly. 2. Igniter electrode broken 3. Igniter electrode not connected to igniter cable 4. Igniter cable pinched or wet 5. Piezo igniter nut is loose 6. Broken igniter cable 7. Bad piezo igniter	1. Replace igniter 2. Replace igniter 3. Reconnect igniter cable 4. Free igniter cable if pinched by any metal or tubing. Keep igniter cable dry. 5. Tighten nut holding piezo igniter to heater cabinet. Nut is located inside heater cabinet at top. 6. Replace igniter cable 7. Replace piezo igniter
OBSERVED PROBLEM	POSSIBLE CAUSE	SOLUTION
Igniter button is pressed Spark at ODS/Pilot No Ignition	1. Gas supply turned off or manual shutoff valve is closed 2. Control knob not in PILOT position 3. Control knob not pressed in while in PILOT position	1. Turn on gas supply or open manual shutoff valve 2. Turn control knob to PILOT position 3. Press in control knob while in PILOT position.

- | | |
|---|--|
| 4. Air in gas lines when installed | 4. Continue to hold down control knob. Repeat igniting operation until air is removed. |
| 5. Depleted gas supply | 5. Contact local propane gas company |
| 6. ODS/Pilot is clogged | 6. Clean ODS/Pilot or replace ODS/Pilot assembly |
| 7. Gas regulator setting is not correct | 7. Replace gas regulator |

**OBSERVED
PROBLEM**

**POSSIBLE
PROBLEM**

SOLUTION

ODS/PILOT lights but flame goes out when control knob is released

- | | |
|---|---|
| 1. Control knob is not fully pressed in | 1. Press control knob completely |
| 2. Control knob not pressed in long enough | 2. After ODS/Pilot lights keep control knob pressed 30 seconds. |
| 3. Safety interlock system has been triggered (if equipped) | 3. Wait 1 minute for safety interlock system to reset. |
| 4. Manual shutoff valve not fully open | 4. Fully open manual shutoff valve. |
| 5. Thermocouple connection loose at control valve. | 5. Hand tighten until snug, then tighten 1/4 turn |
| 6. Pilot flame not touching thermocouple, which allows thermocouple to cool, causing pilot flame to go out. This problem can be caused by one or both of the following:
A) low gas pressure
B) dirty or partially clogged ODS/Pilot | 6. A) contact local propane gas company
B) Clean ODS/Pilot (See Cleaning and Maintenance), or replace ODS/Pilot assembly |
| 7. Control valve damaged | 7. Replace valve control |

OBSERVED PROBLEM	POSSIBLE CAUSE	SOLUTION
Burner does not light after ODS/ Pilot is lit	<ol style="list-style-type: none"> 1. Burner orifice is clogged 2. Inlet gas pressure is too low 	<ol style="list-style-type: none"> 1. Clean burner (see Cleaning and Maintenance) or replace burner orifice 2. Contact local propane gas company
Delayed ignition of burner	<ol style="list-style-type: none"> 1. Manifold pressure is too low 2. Burner orifice is clogged 	<ol style="list-style-type: none"> 1. Contact local propane gas company. 2. Clean burner (see Cleaning and Maintenance) or replace burner orifice
Burner backfiring during combustion	<ol style="list-style-type: none"> 1. Burner orifice is clogged or damaged 2. Burner damaged 3. Gas regulator defective 	<ol style="list-style-type: none"> 1. Clean burner (see Cleaning and Maintenance) or replace burner orifice 2. Replace burner 3. Replace gas regulator
Slight smoke or odor during initial operation	<ol style="list-style-type: none"> 1. Residues from manufacturing process 	<ol style="list-style-type: none"> 1. Problem will stop after a few hours of operation
Heater produces a whistling noise when burner is lit	<ol style="list-style-type: none"> 1. Turning control knob to HI position when burner is cold (if equipped with this type of valve) 2. Air in gas line 3. Air passageways on heater blocked 4. Dirty or partially clogged burner orifice 	<ol style="list-style-type: none"> 1. Turn control knob to LOW position and allow to warm 2. Operate burner until air is removed from line. Call local propane company to check gas line. 3. Observe minimum installation clearances 4. Clean burner or replace orifice

WARNING

IF YOU SMELL GAS:

- * **SHUT OFF GAS SUPPLY**
- * **DO NOT TRY TO LIGHT APPLIANCE**
- * **DO NOT TOUCH ANY ELECTRICAL SWITCH; DO NOT USE ANY PHONE IN YOUR BUILDING**
- * **IMMEDIATELY CALL YOUR GAS SUPPLIER FROM A NEIGHBOR'S PHONE. FOLLOW THE GAS SUPPLIER'S INSTRUCTIONS.**
- * **IF YOU CANNOT REACH YOUR GAS SUPPLIER, CALL THE FIRE DEPARTMENT.**

IMPORTANT: Operating heater where impurities in the air exist may create odors. Cleaning supplies, paint, paint remover, cigarette smoke, cements and glues, new carpet or textiles, etc. create fumes. These fumes may mix with combustion air and create odors.

OBSERVED PROBLEM	POSSIBLE CAUSE	SOLUTION
Heater produces a clinking/ticking noise just after burner is lit or shut off	1. Metal expands while heating or contracts while cooling.	1. This is common with most heaters. If noise is excessive, contact a qualified service person.
Heater produces unwanted odors	1. Heater burning vapors from paint, hairspray, glues, etc. (See Important above) 2. Low fuel supply 3. Gas leak (See WARNING above)	1. Ventilate room. Stop using odor causing products while heater is running. 2. Refill supply tank. 3. Locate and control all leaks. See Checking Gas Connections.
Heater shuts off in use (ODS operates)	1. Not enough fresh air is available. 2. Low line pressure 3. ODS/Pilot is partially clogged	1. Open window/door for ventilation 2. Contact local propane co. 3. Clean ODS/Pilot
Gas odor even when control knob is in OFF position	1. Gas leak (See WARNING , above). 2. Control valve defect	1. Locate and correct all leaks (see Checking Gas Connections) 2. Replace control valve
Gas odor during combustion	1. Foreign matter between control valve and burner 2. Gas leak (See WARNING , above).	1. Remove foreign matter from gas tubing 2. Locate and correct all leaks (see Checking Gas Connections).



SERVICING



Repair and replacement work should only be performed by a qualified service technician.

Always shut off the gas supply and make sure heater is cool before beginning any service operation. Check for gas leaks after servicing.



REPAIR PARTS



A parts list with exploded view follows. Always include correct name, part number, and model number of the heater when ordering service parts. Please contact your local dealer or Distributor when ordering, or if one is not available, you may contact:

New Buck Corporation
P.O. Box 69
Spruce Pine, NC 28777

(828)-765-6144

REPLACEMENT PARTS

ITT VALVE

(Picture on page 36)

KEY#	PART DESCRIPTION	PART NUMBER
1.	Female Terminals	PE 5X425
2.	Regulator (LP) Maxitrol	PE RV 12LF90
2.	Regulator (NAT) Maxitrol	PE RV 12LF30
3.	Pilot (NAT) Copreci	PE 2150053 - NAT
3.	Pilot (LP) Copreci	PE 2150054 - LP
4.	Generator ITT	PE G251F245
5.	Carling Switch	PE RA911VB
6.	Piezo Striker	PE 124461
7.	Piezo 14" Igniter Wire	PE UL3304
8.	Pilot Tube 1/4"	MF 147AL
9.	Burner Tube 3/8"	PO 38117ALMTUB
10.	3/8" Supply Tube	PO 38812ALMTUB
11.	3/8" IPT Male & Female Connector	PH 4866
12.	3/8" x 3/8" Elbow (Brass)	PH 4966
13.	Jumper Wire 6"	PE 65 JUMPER
14.	Burner	PO DTBURN
15.	Orifice Holder	PO 54ORFHLD
16.	Orifice	PO ORIFICE
17.	Valve (LP) ITT	PE B67SA-233
17.	Valve (NAT) ITT	PE B67RA-234
18.	Burner Base	PO 300010
19.	1/8" x 1/4" Compression Adapter	PH 6842
20.	Regulator Tube 1/4"	MF 147AL

OTHER PARTS (NOT SHOWN)

21.	Fan Motor	PE SBRO84
22.	Power Cord	PE 400240
23.	Strain Release	PE 400320
24.	Thermostat	PE 400130
25.	Male Terminals	PE 5X428
26.	Jumper Wire 12"	PE 12JUMPER
27.	Gas Log Set	PO C-3329
28.	Fan Speed Control Label	PE KB9724
29.	Rheostat	PE BC 204
30.	Rheostat Knob	PE BC 204A
31.	Heyco 1-1/4" Grommet	PE HEYCO2883

